

CM-40, CM-41 & CM-60 Series Push Plate



INSTALLATION INSTRUCTIONS

THIS PACKAGE INCLUDES:

- (1) "All Active" Push Plate
- (1) Parts kit



CM-40



CM-41



CM-60

1. GENERAL DESCRIPTION

Camden Door Controls CM-40 (4 1/2" round faceplate), CM-41 (4 1/2" round faceplate with 4 1/2" square back plate) and CM-60 Series (6" round faceplate) 'all active' push plate switches are heavy-duty, weather resistant and ADA compliant door activation switches. The CM-40 and CM-41 switches mount to standard 2 x 4 electrical boxes. The faceplates are stainless steel or solid brass, and the assembly is designed for easy installation in single-gang electrical boxes, or with included adapter plate – double-gang and 4x4 boxes. The switches are UL/CSA approved, and rated 15 amps @ 30 VDC. The push switches are offered with different graphics, and in various architectural finishes. Watertight configurations are also available.

2. SPECIFICATIONS

Voltage	12/24V DC
Contact Type	SPDT FORM 'C
Switch Type	Momentary
Contact Rating	15A @ 30 VDC
Temp. Range	-40°F to 140°F (-40°C to 60°C)
Std. Finish	CM-40, CM-41 & CM-60: US32/630
Dimensions	<p>CM-40 SERIES: 4 1/2" DIA x 1 3/8"D (114mm x 34mm)</p> <p>CM-41 SERIES: 4 1/2" H x 4 1/2" W x 1 3/8"D (114mm x 114mm x 34mm)</p> <p>CM-60 SERIES: 6" DIA x 1 3/8" D (152mm x 34mm)</p>

3. APPLICATION

Camden all-active switches are designed for areas where an easy-to-activate, high visibility switch is desired. Ideal for high-traffic areas, hospitals, wheelchair access, seniors' residences, etc. They can be surface or flush mounted.

Camden all-active switches are designed to control electric strikes, electromagnetic locks, and automatic doors. They may also be used for shunting, bypassing alarms, request to exit, timed functions, and many other applications.

The switches are made for high frequency usage, in both indoor and outdoor environments. Camden switches are versatile, and can be supplied in various configurations and finishes, to suit any commercial, industrial, or institutional application.

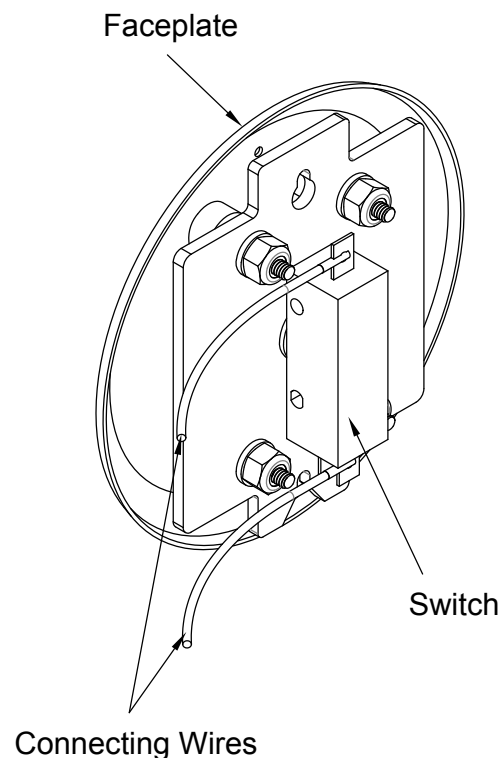

CM-40, CM-41 & CM-60 Series Push Plate

INSTALLATION INSTRUCTIONS

4. DIMENSIONS

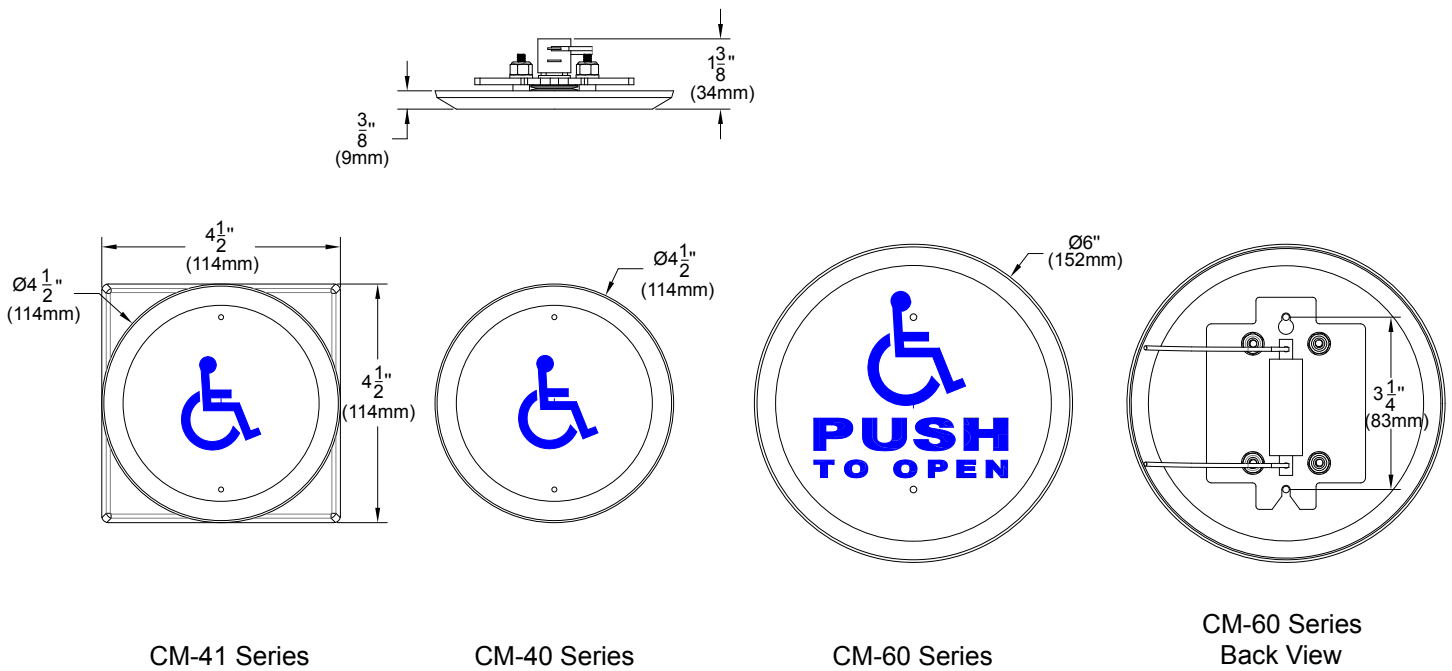

CM-41 Series

CM-40 Series

CM-60 Series

CM-60 Series Back View

5. INSTALLATION AND WIRING

Mounting Options:

- The CM-40, CM-41 and CM-60 can be installed using either flush or surface mounting methods.

Selecting a Surface Mount Enclosure:

- Refer to the "Parts and Information" section (Page 5) to choose a suitable Enclosure.

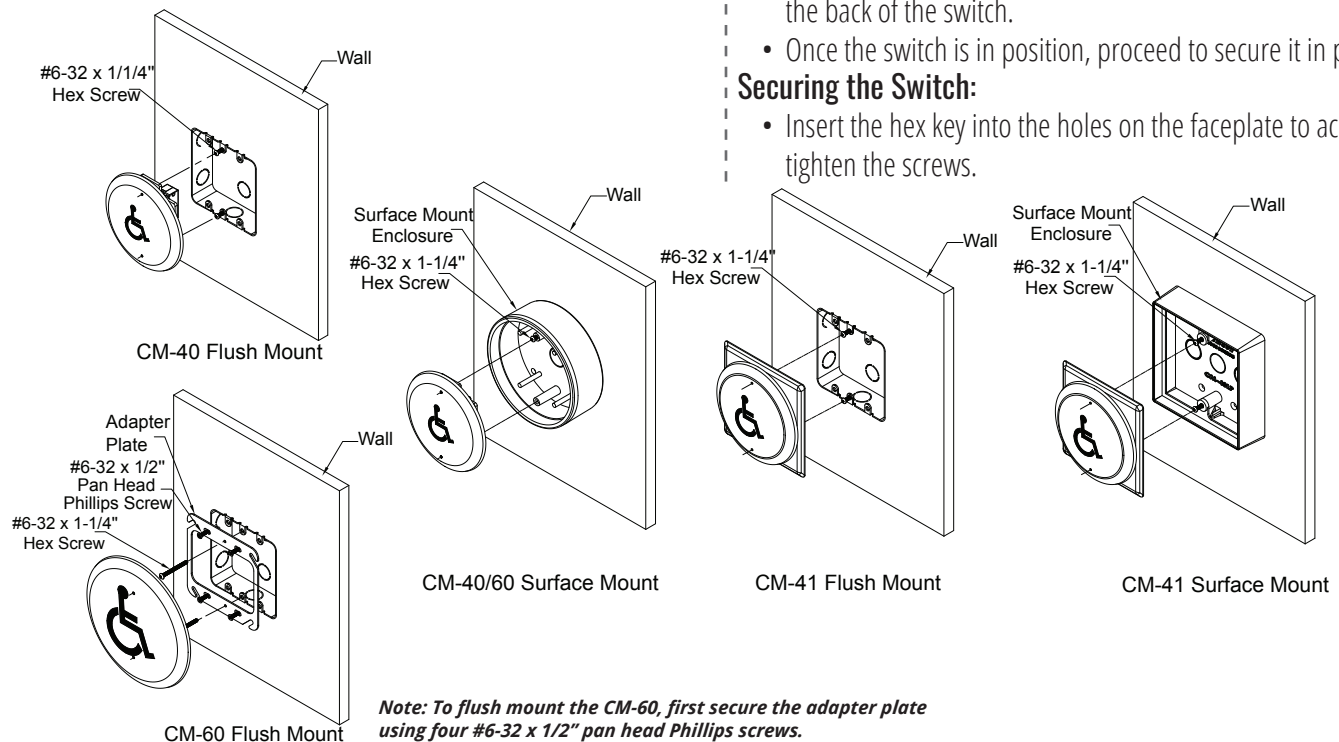

Note: To flush mount the CM-60, first secure the adapter plate using four #6-32 x 1/2" pan head Phillips screws.

Installation Process:

- Use two #6-32 x 1 1/4" screws for mounting.
- Insert the screws into the designated mounting holes, but do not fully tighten them at this stage.

Attaching the Switch:

- Align the switch so that the screw heads slide into the slots on the back of the switch.
- Once the switch is in position, proceed to secure it in place.

Securing the Switch:

- Insert the hex key into the holes on the faceplate to access and tighten the screws.

WIRING

Switch is not pressed
 SPDT

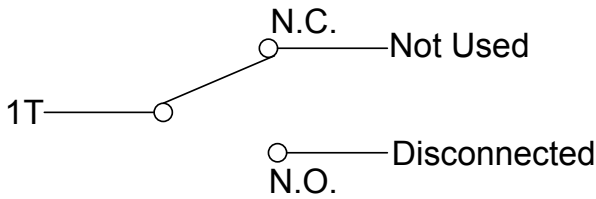

Switch is pressed
 SPDT

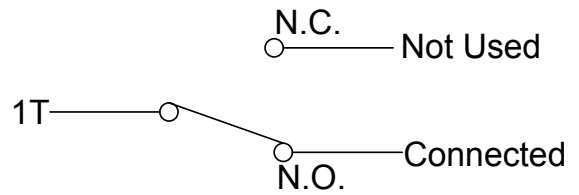

Momentary: When the switch is pressed, the current pole will change to the opposite state until released

WIRING LAYOUT				
SWITCH STATE	COM Terminal	NO Terminal	NC Terminal	Connection Status
Not Pressed	Connected	Disconnected	Not Used	No Connection
Pressed	Connected	Connected	Not Used	COM connected to NO

6.PARTS INFORMATION

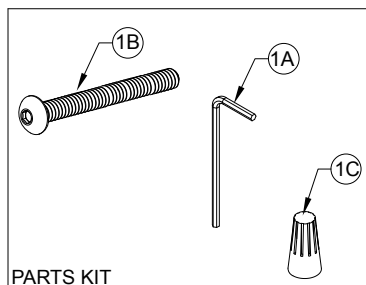
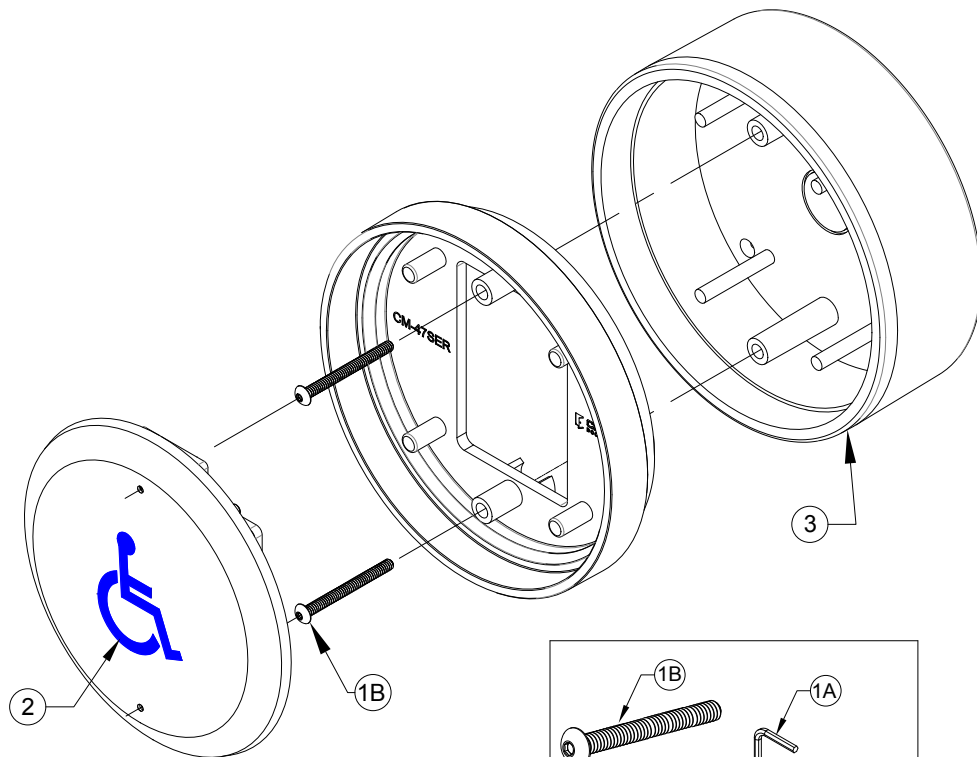

60-34B031: CM-40 & CM-41 Series Parts Kit

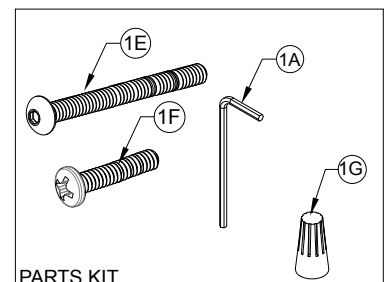

60-34B032: CM-60 Series Parts Kit

CM-40, CM-41 & CM-60 Series Push Plate

INSTALLATION INSTRUCTIONS

MODEL NUMBERS		
MODEL NUMBER	DESCRIPTION	
CM-40 Series	4 1/2" ROUND PUSH PLATE SWITCH	
CM-41 Series	4 1/2" ROUND PUSH PLATE SWITCH WITH SQUARE BACK PLATE	
CM-60 Series	6" ROUND PLATE SWITCH	
PARTS KIT		
ITEM NUMBER	PART NUMBER	DESCRIPTION
	FOR CM-40 & CM-41 SERIES	
1	60-34B031	(A) SMALL HEX KEY 5/64" SHORT ARM (B) 6-32 X 1-1/4" S/S BUTT HEAD SOCKET CAP SCREW (C) GREY PLASTIC WIRE NUT C/W SPRING
	FOR CM-60 SERIES	
	60-34B032	(D) SMALL HEX KEY 5/64" SHORT ARM (E) 6-32 X 1-1/4" BUTT HEAD SOCKET CAP SCREW (F) 6-32 X 1/2" PAN ZINC PLATED PHILLIPS SCREW (G) GREY PLASTIC WIRE NUT C/W SPRING
FACE PLATE GRAPHIC OPTIONS		
ITEM NUMBER	PART NUMBER	DESCRIPTION
2	CM-XX/1	BLANK STAINLESS-STEEL FACEPLATE
	CM-XX/2	WHEELCHAIR LOGO IN BLUE IN BLUE
	CM-XX/A2	FACEPLATE WITH MAN IN ACTION LOGO IN BLUE
	CM-XX/2AL	WHEELCHAIR LOGO WITH ARROW POINTING LEFT IN BLUE
	CM-XX/2AR	WHEELCHAIR LOGO WITH ARROW POINTING RIGHT IN BLUE
	CM-XX/3	"PUSH TO OPEN" GRAPHICS IN BLACK
	CM-XX/3F	"POUSSEZ POUR OUVRIR" GRAPHICS IN BLACK
	CM-XX/4	WHEELCHAIR LOGO WITH "PUSH TO OPEN" LOGO IN BLUE
	CM-XX/A4	MAN IN ACTION LOGO WITH 'PUSH TO OPEN' LOGO IN BLUE
	CM-XX/4AL	WHEELCHAIR LOGO WITH " PUSH TO OPEN AND ARROW POINTING TO THE LEFT" LOGO IN BLUE
	CM-XX/4AR	WHEELCHAIR LOGO WITH " PUSH TO OPEN AND ARROW POINTING TO THE RIGHT" LOGO IN BLUE
	CM-XX/4F	WHEELCHAIR LOGO WITH "POUSSEZ POUR OUVRIR" LOGO IN BLUE
	CM-XX/8	"PUSH TO LOCK" LOGO IN BLACK
	CM-XX/8B	LOCK SYMBOL IN BLACK WITH " PUSH TO LOCK" LOGO IN BLACK
	CM-XX/8F	"POUSSEZ POUR VERROUILLER" GRAPHICS IN BLACK
	CM-XX/8D	"PUSH TO LOCK DOOR" GRAPHICS IN BLACK
Adapter Plate*		
ITEM NUMBER	PART NUMBER	DESCRIPTION
-	60-40C020	Adapter Plate for CM-60 Only

* For CM-60 Only



COMPATIBLE MOUNTING BOXES		
ITEM NUMBER	PART NUMBER	DESCRIPTION
	FOR CM-40 SERIES	
3	CM-47S	SURFACE, ROUND, STANDARD DEPTH, PROVISION FOR WIRELESS. BLACK POLYMER (ABS) FLAME AND IMPACT RESISTANT, 5" X 1-3/4"D
	CM-49	Surface/Flush mount kit includes CM-49A, CM49B, CM-49C and CM-49G. 8-3/4" x 2
	CM-59s	Surface, Round, Standard Depth. Heavy gauge stainless steel 7-3/4" x 1-1/8"
	FOR CM-41 SERIES	
	CM-43CBL	Black polymer (ABS) Surface box, standard depth, provision for wireless, double wall
	CM-48AL	Anodized aluminum surface box, shallow depth
	CM-44	Surface Box, Shallow Depth, offset mount (on jamb). Stainless Steel 4-1/2" W x 4-1/2"H x 5/8"D.
	CM-540b	Surface Box, Shallow Depth. Flame and Impact resistant black polymer (ABS) 4-13/16" x 4-13/16" x 5/8"
	CM-67	Sleeve Cover for standard double gang surface box. Heavy gauge stainless steel
	CM-49C	Adapter plate for mounting on double gang or 4" Square box 4" x 1/16"
	FOR CM-60 SERIES	
	CM-69S	Surface, Round Standard Depth, provision for wireless. black polymer (ABS) Flame and impact resistant, 6-1/2" x 1-3/4"D
	CM-89s	Surface, Round Standard Depth. Heavy gauge stainless steel 9-5/8" x 1-1/2"