

CX-ED2071 & CX-ED2079 'Universal' Low Profile Grade 2 Electric Strikes



BEST VALUE



RUGGED DESIGN

Camden CX-ED2071 low profile 'Universal' grade 2 'ANSI' electric strikes for cylindrical locksets provide exceptional value, for installations that require 8 - 16V AC/DC operation. CX-ED2071 includes (3) faceplates, selectable fail safe / fail secure operation, and horizontal adjustability of the strike body.

Camden CX-ED2079 low profile 'Universal' grade 2 'ANSI' electric strikes for cylindrical locksets also provide great value with (3) faceplates, selectable 12/24V AC/DC voltage, fail safe / fail secure operation and horizontal adjustment of the strike body. UL 1034 Burglary Listed.

The CX-ED2079-1 includes all the same great features as the CX-ED2079, just with (1) 'ANSI' square faceplate.

Features

- Centerline latch entry, for cylindrical locksets
- 1/2" - 5/8" (13mm - 16mm) latch projection
- Field Selectable fail safe / fail secure operation
- Horizontal adjustability
- Low profile strike body
- 1 or 2 latch and deadbolt monitoring switches
- CX-ED2071: 8V - 16V strike with (3) stainless steel faceplates 'ANSI' square, hollow metal door and wood door
- CX-ED2079: 12/24V strike with (3) stainless steel faceplates: 'ANSI' Square, hollow metal door and wood door
- CX-ED2079-1: 12/24V strike with (1) stainless steel 'ANSI' square faceplate
- 5 year warranty

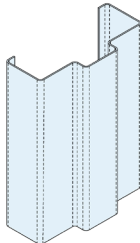
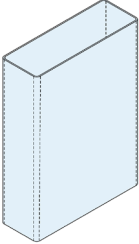
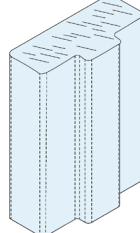

DOOR FRAME TYPES		
Hollow Metal Frame	Aluminum Frame	Wood Frame
		

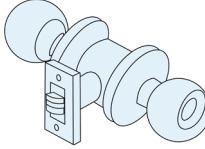
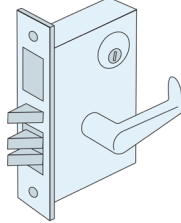
COMPATIBLE LOCKSETS	
Cylindrical Lockset	Mortise Locks
	

SPECIFICATIONS			
VOLTAGE:	CX-ED2071: 8 - 16V, AC/DC CX-ED2079: 12/24V, AC/DC	MODE:	Field selectable fail safe/fail secure
CURRENT DRAW:	CX-ED2071: 305mA @ 8VDC, 625mA @ 16VDC, 190mA @ 8VAC, 460mA @ 16VAC CX-ED2079: 300mA @ 12VDC, 150mA @ 24VDC	OPERATION:	AC - Buzz, DC - Silent
STATIC STRENGTH:	1,000 Lbs.	DUTY:	CX-ED2071: Intermittent CX-ED2079: Continuous
ENDURANCE:	CX-ED2071 & CX-ED2079: 700,000 cycles (Factory Tested) CX-ED2079: 250,000 cycles (UL Verified)	MOUNTING:	Non-handed
		DYNAMIC STRENGTH:	50 Ft-Lbs.
		DIMENSIONS :	3-3/8" H x 1-7/8" W x 1-7/32" D (86mm x 47mm x 31mm)

ORDERING INFORMATION	
MODEL	
CX-ED2071	'Universal' electric strike, 8 - 16V AC/DC, fail safe/fail secure operation, horizontal adjustment, with (3) stainless steel faceplates (CX-ESP1B, ESP3B & ESP4B)
CX-ED2079*	'Universal' electric strike, 12/24V AC/DC, fail safe/fail secure operation, horizontal adjustment, with (3) stainless steel faceplates (CX-ESP1B, CX-ESP3B & ESP4B)
CX-ED2097-1*	'Universal' electric strike, 12/24V, AC/DC, fail safe/fail secure operation, horizontal adjustment, with (1) stainless steel faceplate (EX-ESP1B)

*Security listed UL 1034 UL294



ORDERING INFORMATION

INCLUDED IN PACKAGE

CX-ESP1B	'ANSI' Square, 4-7/8" x 1-1/4", stainless steel
CX-ESP3B	Hollow Metal Door, 6-7/8" x 1-1/4", stainless steel
CX-ESP4B	Wood Door, 7-15/16" x 1-7/16", stainless steel

OPTIONAL FACEPLATES

CX-ESP2B	'ANSI' Round, 4-7/8" x 1-1/4", stainless steel
CX-ESP1B-BK	'ANSI' Square, 4-7/8" x 1-1/4", all-black finish (BHMA 622, US19)
CX-ESP2B-BK	'ANSI' Round, 4-7/8" x 1-1/4", all-black finish (BHMA 622, US19)
CX-ESP3B-BK	Hollow Metal Door, 6-7/8" x 1-1/4", all-black finish (BHMA 622, US19)
CX-ESP4B-BK	Wood Door, 7-15/16" x 1-7/16", all-black finish (BHMA 622, US19)

CUTTING JIGS

CX-JIG1	For installing 'ANSI' Round faceplates
CX-JIG2	For Hollow metal door faceplates

LIP EXTENSION BRACKETS

CX-ED-LIP1	1" Lip extension for 'ANSI' strikes (stackable)
CX-ED-LIP2	2" Lip extension for 'ANSI' strikes

DIMENSIONS

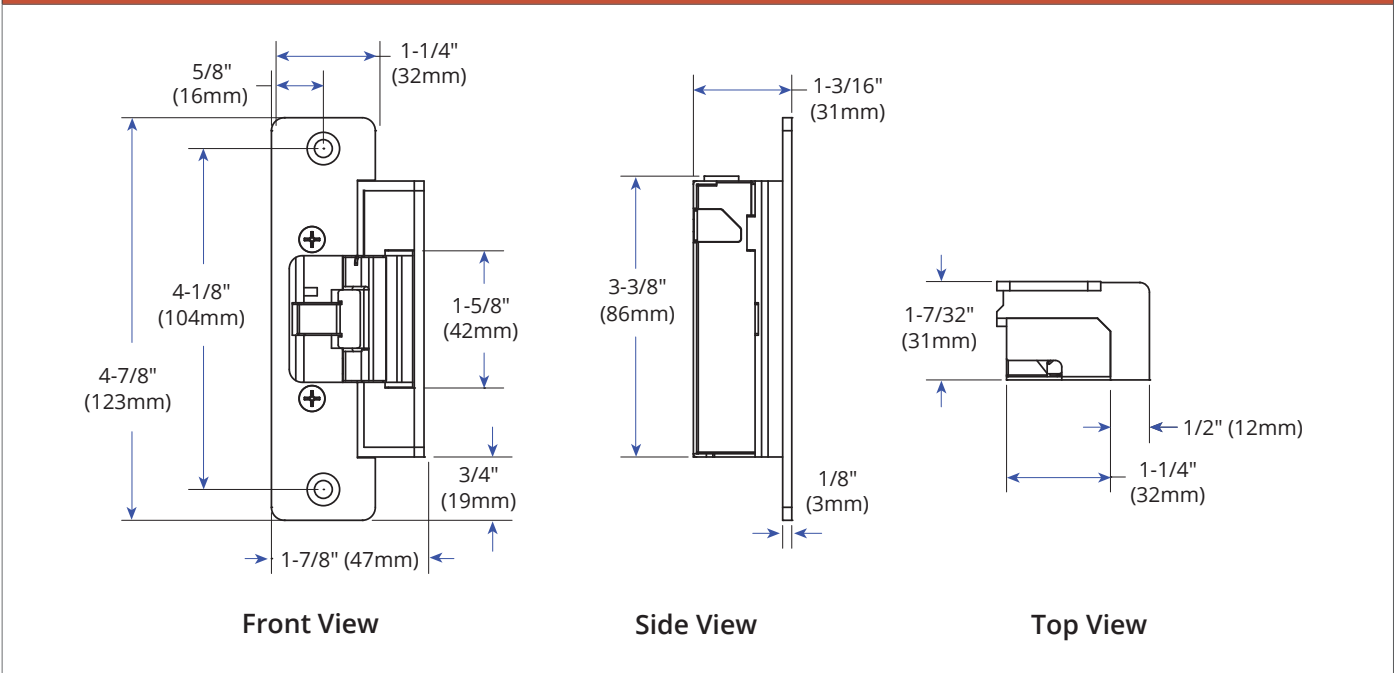

FACEPLATE DIMENSIONS

INCLUDED IN PACKAGE

OPTIONAL FACEPLATE

'ANSI' Square

Hollow Metal Door

Wood Door

'ANSI' Round

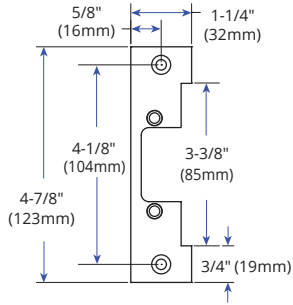

CX-ESP1B

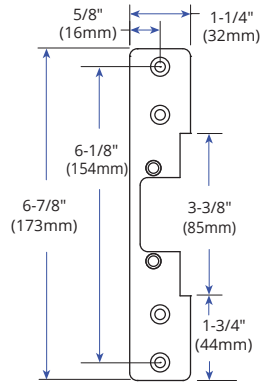

CX-ESP3B

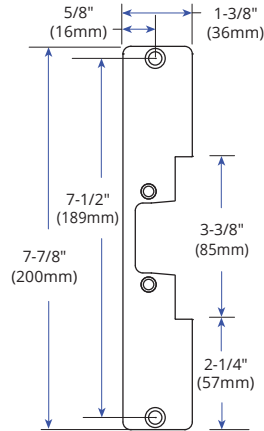

CX-ESP4B

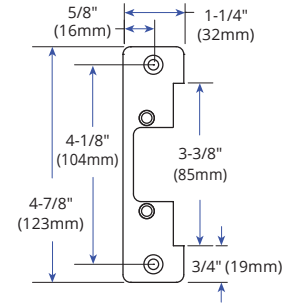

CX-ESP2B



Opening New Doors to Innovation, Quality, and Support!

2395 Skymark Ave, Mississauga, ON Canada L4W 4Y6 • Toll Free: 1(877) 226-3369 (CAMDEN9)
Tel: (905) 366-3377 | Fax: (905) 366-3378 | E-mail: info@camdencontrols.com | www.camdencontrols.com



Part #: MKTG-LIT-SP-CXED20712079