

















# CX Series Magnetic Lock Mounting Accessories

CX-91S and CX-92S SERIES ACCESSORIES			
<b>Brackets</b>			
<p><b>CX-MA0610</b> L bracket for 600 lbs. magnetic lock</p> 	<p><b>CX-MA0613</b> LZ bracket for 600 lbs. magnetic lock</p> 	<p><b>CX-MA1210</b> L bracket for 1,200 lbs. magnetic lock</p> 	<p><b>CX-MA1213</b> LZ bracket for 1,200 lbs. magnetic lock</p> 
<b>Spacer Bars</b>			
<p><b>CX-MA0614-12</b> 1/2" spacer bar for 600 lbs. magnetic lock</p> 	<p><b>CX-MA0614-38</b> 3/8" spacer bar for 600 lbs. magnetic lock</p> 	<p><b>CX-MA0614-58</b> 5/8" spacer bar for 600 lbs. magnetic lock</p> 	
<p><b>CX-MA1214-12</b> 1/2" spacer bar for 1,200 lbs. magnetic lock</p> 	<p><b>CX-MA1214-38</b> 3/8" spacer bar for 1,200 lbs. magnetic lock</p> 	<p><b>CX-MA1214-58</b> 5/8" spacer bar for 1,200 lbs. magnetic lock</p> 	
<b>Armature / Mounting Kits</b>			
<p><b>CX-MA0612</b> Armature housing for 600 lbs. magnetic lock</p> 	<p><b>CX-MA0611</b> Glass (1/2" thick) mounting kit for 600 lbs. magnetic lock</p> 	<p><b>CX-MA1212</b> Armature housing for 1,200 lbs. magnetic lock</p> 	<p><b>CX-MA1211</b> Glass (1/2" thick) mounting kit for 1,200 lbs. magnetic lock</p> 
<p><b>CX-MA1215-95</b> Split Armature for 1,200 lbs. magnetic lock 9.5mm</p> 	<p><b>CX-MA1215-16</b> Split Armature for 1,200 lbs. magnetic lock 16mm</p> 		

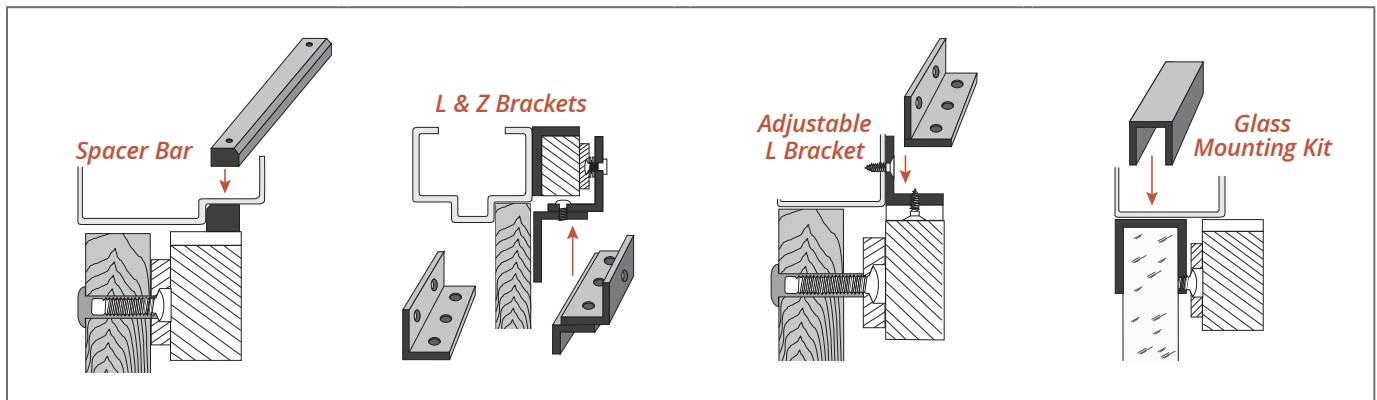

Opening New Doors to  
Innovation, Quality and Support!

5502 Timberlea Blvd. Mississauga, ON Canada L4W 2T7 • Toll Free: 1 877 226-3369 (CAMDEN9)  
Tel: (905) 366-3377 • Fax: (905) 366-3378 • E-mail: info@camdencontrols.com • www.camdencontrols.com



Part #: MKTG-LIT-SP-MAGACC